

PUMPING CAPACITY OF PITCHED BLADE MULTI-STAGE IMPELLERS

Tomáš Jirout*

Czech Technical University in Prague, Faculty of Mechanical Engineering, Department of Process Engineering, Technická 4, 166 07 Prague 6, Czech Republic

This paper extends knowledge about flow in an agitated batch with pitched blade multi-stage impellers. Effects of various geometrical parameters (blade number, distance between impellers) of pitched blade multi-stage impellers on pumping ability have been investigated. Axial velocity profiles were measured by LDA (Laser Doppler Anemometry). Axial pumping capacities were obtained by integration of measured axial velocity profiles in outflow from impellers. Main attention was focused on the effect of the distance between impellers in multi-stage configurations, on their pumping capacity and flow in the mixing bath in comparison with an independently operating pitched blade impeller with the same geometry. In case of a relatively close distance between impellers $H_3/d = 0.5 - 0.75$, the multi-stage impeller creates only one circulation loop and the impellers itself behave identically as pumps in series. However for relative higher distance of impellers than $H_3/d = 1.25$, the multi-stage impeller creates two separated circulation loops.

Keywords: pitched blade impeller, multi-stage impeller, impeller pumping capacity, velocity profile, laser Doppler anemometry

1. INTRODUCTION

Apparatuses with mechanical impellers are preferably used in processes with the prevailing liquid phase. Currently 80% of application processes consist of blending and at the same time 50 % of them deal with solid-liquid suspensions (Seichter and Pešl, 2005). Mixing of highly concentrated suspensions is also a very frequent operation in many industries. Just-suspended impeller speed and impeller speed are crucial parameters for homogenisation and circulation. They also play an important role for the distribution of solid-phase in the agitated apparatuses depending on the impeller speed.

These process parameters are affected by flow in agitated batch and mainly by impeller pumping capacity (Fořt, 1986). The effect of impeller pumping capacity and just-suspended impeller speed for standard mixing equipment is shown in e.g. Wu et al. (2001) or Wu et al., (2002). To ensure homogeneity of the suspension it is necessary to extend an intensive flow to the whole mixing batch, which can be achieved using multi-stage axial impellers (Moravec et al., 2009). Generally, multi-stage impellers are commonly installed in slender vessels where individual impellers create independent circulation zones in the agitated batch. However, it is often necessary to ensure circulation in the whole mixing batch. It could be provided by the installation of multi stage impellers into standard agitated vessels with height of the liquid level approximately equal to the diameter of vessel. The distance between impellers in a multi-stage arrangement has a strong effect on flow patterns in the mixing batch. Many recommendations for the arrangement of multi-stage impeller working in a slender vessel are very often given in the literature, e.g. for gas-liquid reactors in (Bouaifi and Roustan, 2000). Multi-

*Corresponding author, e-mail: Tomas.Jirout@fs.cvut.cz

stage impellers consist of either radial impellers (e.g. Rushton turbine), axial impellers (e.g. pitched blade impellers, hydrofoil impellers), or their combination (frequently lower radial and upper axial impellers). Thus, their mutual configuration is chosen so that each impeller creates a separate circulation loop and the flow does not influence impellers used in an apparatus. Afterwards the momentum transfer in the mixing batch is shared among these loops. The recommended distance between impellers in a multi-stage arrangement for this purpose is in the range from one to two times of the impeller diameter. This fact is also mentioned in various studies focused on the application of multi-stage impellers in slender vessels, e.g. (Vrábel et al., 2000; Pan et al., 2008; Xia et al., 2009). More detailed analysis of the effect of mutual distance of impellers in multi-stage arrangement on flow in the mixing batch is listed in the general review (Gorate et al., 2000). Separate loops of circulation begin to form when the distance between impellers is greater than the diameter of impellers ($H_3/d > 1$). With certainty we can talk about that the circulation loops formed by impellers do not affect each other for the distance of impellers to be equal to approximately twice the impeller diameter. Further increasing the distance between impellers creates dead zones in the mixing batch. Conversely, if the distance between two impellers is less than their diameter ($H_3/d < 1$) only one circulation loop is formed in the mixing batch and a multi-stage impeller acts as a single impeller system. These conclusions corresponded with the recommendations for multi-stage impellers consisting of a combination of radial-radial, radial-axial or opposite pumping axial-axial impellers as it is discussed in (Fořt et al., 1989).

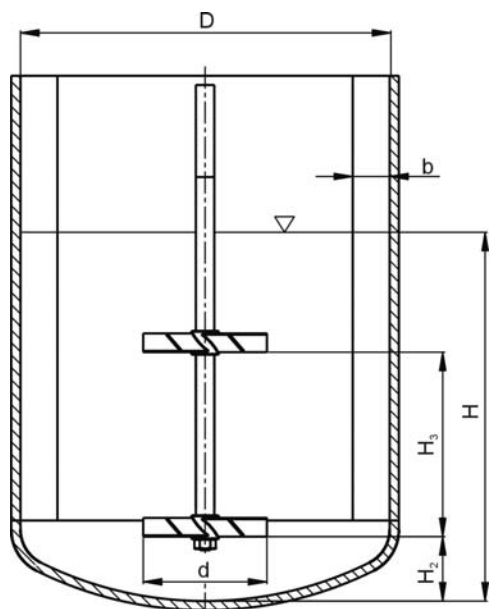

Fig. 1. Layout of geometrical arrangement of mixing equipment;
 $H/D = 1$, $b/D = 0.1$, $d/D = 0.36$, $H_2/d = 0.5$

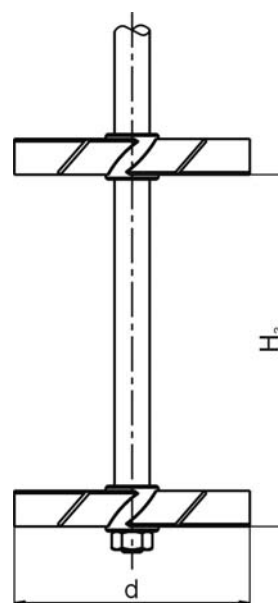

Fig. 2. Layout of geometrical arrangement of pitched blade multi-stage impeller with pitch angle 45° ;
 $H_3/d = 0.5 \div 1.25$

2. EXPERIMENTAL

Experiments were carried out in a pilot plant transparent dished bottomed cylindrical vessel equipped with four radial baffles. The geometrical configuration of the mixing set-up is shown in Fig. 1. The internal vessel diameter was $D = 400$ mm. The height of the liquid level was equal to the vessel diameter $H = D$. The effects of the number of blades (six 6PBT and three 3PBT) and the distance between the impellers $H_3/d = 0.5-1.25$ of pitched blade multi-stage impellers (see Fig. 2) on the pumping ability have been investigated. Both impellers (lower and upper) had a relative diameter $d/D = 0.36$. The lower impeller off-bottom clearance was equal to the half of impeller diameter $H_2/d = 0.5$.

The pitch angle of three and six blade impellers was 45°. Four levels of the impeller speed were tested and the frequency of the revolution of the impeller was measured by means of a photoelectric cell with an accuracy ± 1 rev/min. All configurations of the multi-stage impellers have been operated to pump the liquid downwards to the vessel bottom.

The mean velocity field in the impeller discharge flow just below the impeller rotor region was measured by a laser Doppler anemometer (LDA). A DANTEC 55X two component modular series LDA and its associated BSA data processor, connected with a PC, was used for the experiments. The LDA was operated in a forward scatter mode. The laser (5-W Ar ion, manufactured by Spectra Physics USA) and optics were mounted on a bench which had a two-dimensional traversing mechanism. To identify flow reversals correctly, a frequency shift was given to one of the beams by means of a Bragg cell with electronic down-mixing. Two components of the local velocity were measured simultaneously, with positioning accuracy ± 0.1 mm. The sample size was set at 20,000 items for each velocity measurement, and the mean time (averaged) value from all the samples was calculated.

3. EXPERIMENTAL RESULTS

The axial pumping capacity of the tested impellers $Q_{P(ax.)}$ can be expressed in the dimensionless form as the impeller flow rate number (Medek and Fořt, 1979; Nienow, 1997)

$$N_{Q_{P(ax.)}} = \frac{Q_{P(ax.)}}{nd^3} = f(Re) \quad (1)$$

where n is the impeller speed and d is its diameter. The dimensionless axial pumping capacity does not depend on the Reynolds number at the turbulent regime of flow in an agitated batch.

The impeller pumping capacity $Q_{P(ax.)}$ was calculated from the experimentally determined radial profiles of the axial component of the mean velocity in the impeller discharge stream leaving the impeller rotor region. The local value of the mean velocity corresponds to the ensemble average value over the circle of radius r determined by LDA. Assuming axial symmetry of the impeller discharge stream, the impeller pumping capacity can be calculated from the equation

$$Q_{P(ax.)} = \int_{S_{(ax.)}} u_{ax.} dS_{(ax.)} = 2\pi \int_0^{d/2} u_{ax.}(r)r dr \quad (2)$$

An example of the radial profile of dimensionless axial component of the mean velocity $u_{ax.}^* = u_{ax.}/nd$ in the impeller discharge stream leaving the impeller rotor is shown in Fig. 3. This figure provides a relatively good illustration of the independence of the dimensionless quantity $u_{ax.}^*$ to the impeller speed respective Reynolds number corresponding to the fully turbulent regime of the agitated liquid (Medek and Fořt, 1979; Fořt et al. 2002).

The radial profile of the dimensionless axial component of the mean velocity in a liquid leaving the rotor region of the upper and lower impeller constituted a multi-stage impeller for the various distances between impellers is depicted in Figs. 4 and 5 for a value of the Reynolds number $Re = 20\ 000$. This axial velocity profile of the lower pitched six-blade impeller was compared with an independently operating pitched six-blade impeller of the same geometry. The values of the dimensionless axial pumping capacity (impeller flow rate number) calculated from the experimentally determined radial profiles of the axial velocity component according to Eq. (1) and (2) are summarised in Table 1.

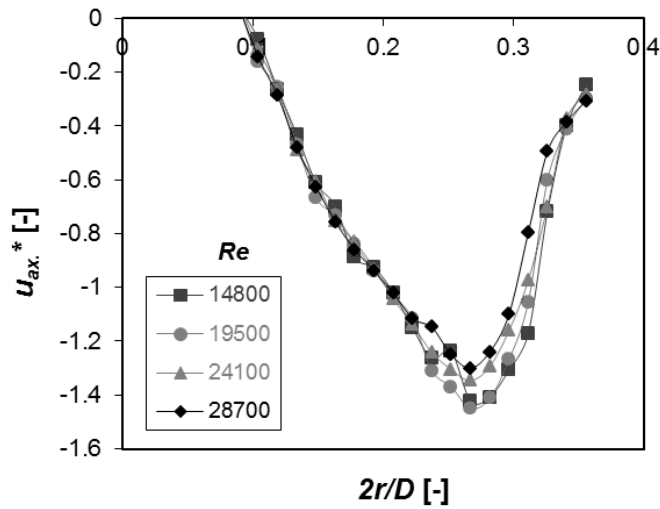

Fig. 3. Radial profile of the dimensionless axial component of the mean velocity in liquid

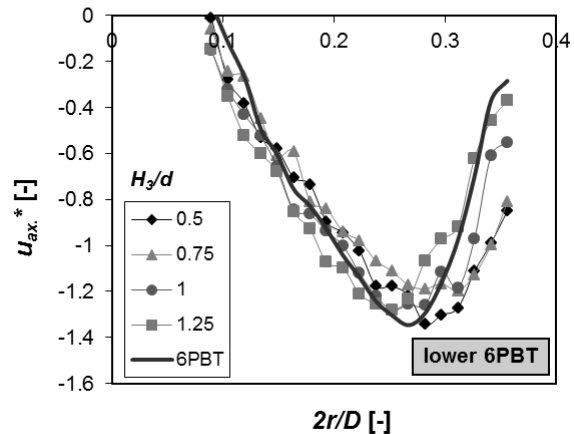
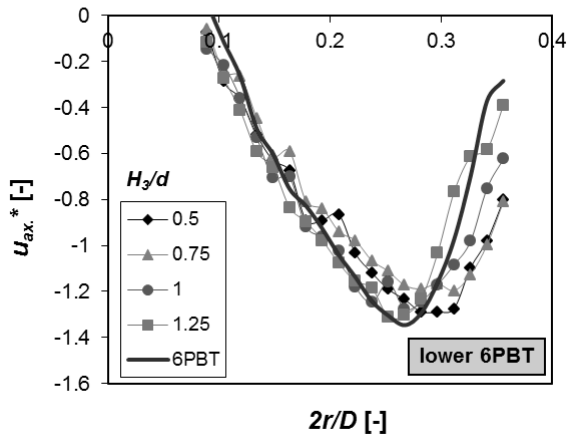
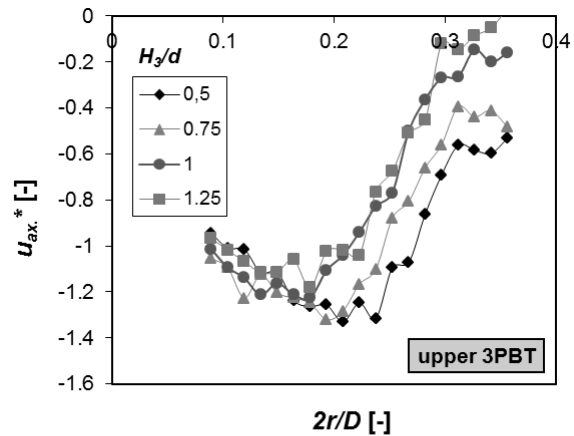
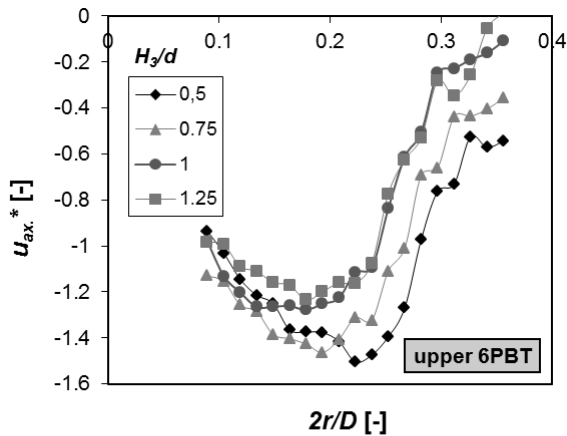

Fig. 4. Radial profile of the dimensionless axial component of the mean velocity in a liquid leaving the rotor region of upper six-blade and lower six-blade impeller constituted multi-stage impeller for various distance between impellers (thick solid line 6PBT – independently operating pitched six-blade impeller)

Fig. 5. Radial profile of the dimensionless axial component of the mean velocity in a liquid leaving the rotor region of upper three-blade and lower six-blade impeller constituted multi-stage impeller for various distance between impellers (thick solid line 6PBT – independently operating pitched six-blade impeller)

Table 1. Dimensionless impeller flow rate number of pitched blade multi-stage impeller

		$N_{Qp(ax.)}$			
		Multi-stage impeller I		Multi-stage impeller II	
		lower	upper	lower	upper
H_2/d	H_3/d	6PBT	6PBT	6PBT	3PBT
0.5	0.5	0.71	0.74	0.71	0.68
0.5	0.75	0.69	0.69	0.69	0.61
0.5	1	0.69	0.54	0.69	0.46
0.5	1.25	0.64	0.51	0.65	0.42

4. DISCUSSION

If velocity profiles at the outflow of multi-stage impellers are compared with calculated values of dimensionless axial pumping capacity, it is evident that flow in an agitated batch is significantly affected by the distance between impellers creating a multi-stage impeller. In case of a relatively close distance between the impellers i.e. $H_3/d = 0.5 \div 0.75$, the suspension pushed out by the upper impeller is sucked by the impeller at the bottom. This fact is evident from the values listed in Table 1. Therefore this configuration can be considered to be a connection of two axial pumps in series. Afterwards, the multi-stage impeller creates only one circulation loop in the agitated batch (see Fig. 6a).

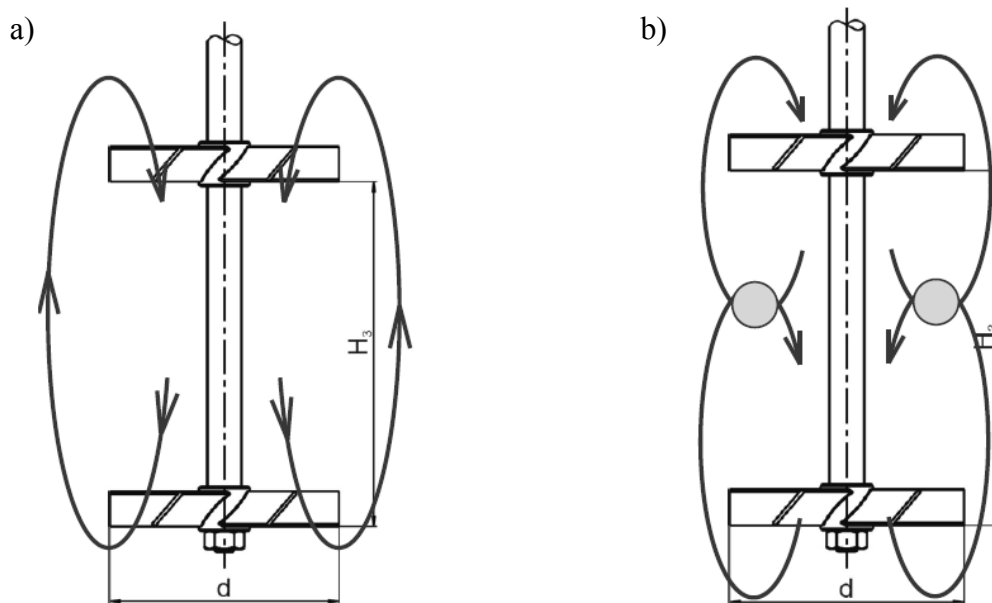

Fig. 6. Flow patterns in mixing batch for multi-stage impeller;
 a) $H_3/d = 0.5 \div 0.75$; b) $H_3/d = 1.25$

The partially radial flow and suction of the fluid from the space between the impellers appear, when the distance between them is increased, i.e. at $H_3/d = 1$. This effect is caused by the bottom impeller which sucks only a part of the suspension from the discharge of the upper impeller. Therefore two circulating zones are formed in the agitated batch.

Further increase in the distance between the impellers over $H_3/d = 1.25$ has already resulted in the creation of two separate circulation loops (see Fig. 6b). If the values of the dimensionless pumping

capacity are compared (see Tab. 1), it is obvious that the pumping efficiency of the bottom pitched six-blade turbine is practically the same as that of the self-pumping impeller working with the same geometry (6PBT – $N_{QP(ax.)} = 0.65$, 3PBT – $N_{QP(ax.)} = 0.56$). This corresponds to the consensus of the radial profile of the dimensionless axial component of the mean velocity in a liquid leaving rotor region of the bottom impeller with velocity profile of the independently working impeller (see Figs. 4 and 5). Both the outflow of the upper impeller and the circulation loop created by the bottom impeller cause a clash of suspension resulting in a pressure increase. Thus, this effect causes a throttling of the outflow for the upper impeller resulting in lower pumping efficiency of the upper impeller in comparison with the self-working one.

5. CONCLUSIONS

Flow in an agitated batch is significantly affected by the distance between axial impellers creating a multi-stage impeller. In case of a relatively close distance between impellers i.e. at $H_3/d = 0.5 \div 0.75$, the suspension pushed out by the upper impeller is sucked by the impeller at the bottom. The multi-stage impeller creates only one circulation loop in the agitated batch. However, for their distance higher than $H_3/d = 1.25$, the lower and upper impellers work independently that means two separate circulation loops are formed.

SYMBOLS

b	baffle width, m
D	vessel diameter, m
d	impeller diameter, m
H	height of the liquid level, m
H_2	impeller off-bottom clearance (measured from the lowest point on the blades), m
H_3	distance between the impellers, m
n	impeller speed, s^{-1}
$N_{QP(ax.)}$	impeller flow rate number,
$Q_{P(ax.)}$	impeller pumping capacity, $m^3 \cdot s^{-1}$
r	radial coordinate, m
Re	Reynolds number, $Re = \frac{nd^2\rho}{\mu}$, -
$u_{ax.}$	axial component of the liquid mean velocity, $m \cdot s^{-1}$
u_{ax}^*	dimensionless axial component of the liquid mean velocity, -

Greek symbols

μ	dynamic viscosity, Pa·s
ρ	liquid density, $kg \cdot m^{-3}$

Abbreviations

3PBT	pitched three-blade impeller with pitch angle 45°
6PBT	pitched six-blade impeller with pitch angle 45°

REFERENCES

Bouaifi M., Roustan M., 2001. Power consumption, mixing time and homogenization energy in dual-impeller agitated gas-liquid reactors. *Chem. Eng. Process.*, 40, 87-95. DOI: 10.1016/S0255-2701(00)00128-8.

- Fořt I., 1986. Flow and turbulence in vessels with axial impellers, In: Uhl V.W., Gray J.B. (Eds.) *Mixing, Theory and Practice*, Vol. III. Academic Press, New York, pp. 133-197.
- Fořt I., Hájek J., Machoň V., 1989. Energetic efficiency of two impellers on the same shaft in cylindrical baffled vessel of high height/diameter ratio. *Collect. Czech. Chem. Commun.*, 54, 2345-2355.
- Fořt I., Jirout T., Sperling R., Jambere S., Rieger F., 2002. Study of pumping capacity of pitched blade impellers. *Acta Polytech.*, 42, 68-72.
- Gogate P.R., Beenackers A.A.C.M., Pandit A.B., 2000. Multiple-impeller systems with a special emphasis on bioreactors: A critical review. *Biochem. Eng. J.*, 6, 109-144. DOI: 10.1016/S1369-703X(00)00081-4.
- Medek J., Fořt I., 1979. Pumping effect of impellers with flat inclined blades. *Collect. Czech. Chem. Commun.*, 44, 3077-3089.
- Moravec J., Jirout T., Rieger F., Kratky L., 2009. Mixing system for highly concentrated fine-grained suspensions. *Polish J. Chem. Technol.*, 11, 52-56. DOI: 10.2478/v10026-009-0043-9.
- Nienow A. W., 1997. On impeller circulation and mixing effectiveness in the turbulent flow regime. *Chem. Eng. Sci.*, 22, 2557-2565. DOI: 10.1016/S0009-2509(97)00072-9.
- Pan Ch., Min J., Liu X., Gao Z., 2008. Investigation of fluid flow in a dual Rushton impeller stirred tank using particle image velocimetry. *Chin. J. Chem. Eng.*, 16, 693-699. DOI: 10.1016/S1004-9541(08)60142-1.
- Seichter P., Peřl L., 2005. Navrhování rotačních míchadel – věda nebo rutina? *CHEMagazín*, 15, 8-11 (in Czech).
- Vrábel P., van der Lans R.G.J.M., Luyben K.Ch.A.M., Boon L, Nienow A.W., 2000. Mixing in large-scale vessels stirred with multiple radial or radial and axial up-pumping impellers: Modeling and measurements. *Chem. Eng. Sci.*, 55, 5881-5896. DOI: 10.1016/S0009-2509(00)00175-5.
- Wu J., Zhu Y., Pullum L., 2001. The effect of impeller pumping and fluid rheology on solid suspension in a stirred vessel. *Can. J. Chem. Eng.*, 79, 177-186. DOI: 10.1002/cjce.5450790201.
- Wu J., Zhu Y., Pullum L., 2002. Suspension of high concentration slurry. *AIChE J.*, 48, 1349-1352. DOI: 10.1002/aic.690480620.
- Xia J-Y., Wang Y-H., Zhang S-L., Chen N., Yin P., Zhuang Y-P., Chu J., 2009. Fluid dynamics investigation of variant impeller combinations by simulation and fermentation experiment. *Biochem. Eng. J.*, 43, 252-260. DOI: 10.1016/j.bej.2008.10.010.

Received 18 February 2013

Received in revised form 16 July 2013

Accepted 05 December 2013