

# Implementation of mathematical model of thermal behavior of electronic components for lifetime estimation based on multi-level simulation

MICHAL FRIVALDSKY, MICHAL PRIDALA, PETER DRGONA

*Faculty of electrical engineering, Department of Mechatronics and Electronics  
University of Zilina  
Univerzitna 1, 010 26, Zilina, Slovakia  
e-mail: Michal.frivaldsky@fel.uniza.sk*

(Received: 20.09.2016, revised: 25.01.2017)

**Abstract:** The main purpose of the paper is the proposal of multi-level simulation, suited for the evaluation of the lifetime of critical electronic devices (electrolytic capacitors). The aim of this issue is to imagine about the expected operation of complex and expensive power electronic systems, when the failure of the most critical component occurs. For that reason, various operational conditions and various physical influences must be considered (e.g. mechanical, humidity, electrical, heat stress), where nonlinearities are naturally introduced. Verification of the proposal is given, whereby the life-time estimation of an electrolytic capacitor operated in a DC-DC converter during various operational conditions is shown. At this point electrical and heat stress is considered for lifetime influence. First, the current state in the field of mathematical modeling of the lifetime for electrolytic capacitors, considering main phenomena is introduced. Next, individual sub-models for multi-level simulation purposes are developed, including a thermal simulation model and electrical simulation model. Several complexities of individual models are mutually compared in order to evaluate their accuracy and suitability for further use. Proper simulation tools have been mutually linked and data transfer was secured, in order to have the possibility of investigation of a lifetime depend on the changes of various variables.

**Key words:** electrolytic capacitor, lifetime model, lifetime estimation, system-level simulation

## 1. Introduction

The paper deals with the proposal of multi-level simulation, suited for the evaluation of the lifetime of critical electronic devices (electrolytic capacitors). Verification of the proposal is given, whereby the life-time estimation of an electrolytic capacitor operated in a DC-DC converter during various operational conditions is shown. The paper describes multi-level simula-

tion design, as well as possible practical application areas. Proposal for target application (DC-DC converters) is initially considered. At first the individual simulation modules are presented. Consequently necessary settings for simulation data exchange between individual modules are described together with the description of relevant physical phenomena. Finally verification of the proposed multi-level simulation system is evaluated, whereby the life-time estimation of an electrolytic capacitor operated in a DC-DC converter during various operational conditions is being shown.

## 2. Life-time estimation model (*LT* estimation methodology)

For determination of expected the lifetime of an electrolytic capacitor during various operation conditions, it is necessary to consider each physical phenomenon, which directly influence component's behavior (1).

$$T = L_0 \cdot K_T \cdot K_R \cdot K_V, \quad (1)$$

where:  $L_0$ ,  $K_T$ ,  $K_R$ , and  $K_V$  are the factors which are influencing the lifetime of a capacitor based on various changes of variables, i.e.,  $L_0$  is the lifetime at nominal ripple and upper category temperature (values from datasheet),  $K_T$  is the temperature factor (ambient temperature),  $K_R$  is the ripple current factor (causing self-heating),  $K_V$  is the voltage factor (operating voltage).

Individual variables are defined below.

**A temperature factor:** the lifetime of elcaps follows the industry wide-well established "10-Kelvin rule" from Arrhenius:

$$K_T = 2^{\frac{T_0 - T_a}{10K}}, \quad (2)$$

where:  $T_0$  is the upper category temperature (datasheet value of maximal allowable capacitor temperature),  $T_a$  is the ambient temperature in the application

**A ripple current:** this factor estimates the impact of the applied ripple current on the self-heating and thus on the lifetime.

$$K_R = K_i^A \frac{\Delta T_0}{10K}, \quad (3)$$

$$A = 1 - \left( \frac{I_a}{I_0} \right)^2, \quad (4)$$

where:  $I_a$  is the ripple current in the application (within actual operation of the system),  $I_0$  is the nominal ripple current at upper category temperature (datasheet value),  $\Delta T_0$  is the core temperature increase (typ. 5EK for 105EC capacitor temperature class and 10EK for 85EC capacitor temperature class),  $K_i$  is the empirical safety factor defined as:

$$T_0 = 105^\circ\text{C}, \quad I > I_0; K_i = 4, \quad I \leq I_0; K_i = 2,$$

$$T_0 = 85^\circ\text{C}, \quad K_i = 2.$$

Voltage factor:

$$K_V = \left( \frac{U_a}{U_r} \right)^{-n}, \quad (5)$$

where:  $U_r$  is the rated voltage,  $U_a$  is actual operating voltage,  $n$  is the exponent, defined as:

$$0.5 \leq \left( \frac{U_a}{U_r} \right) \leq 0.8 \rightarrow n = 3,$$

$$0.8 \leq \left( \frac{U_a}{U_r} \right) \leq 1 \rightarrow n = 5.$$

The final form of the lifetime estimation model of the electrolytic capacitor is:

$$LT = L_0 \cdot 2^{\frac{T_0 - T_a}{10K}} \cdot K_i^{\frac{A - A T_0}{10K}} \cdot \left( \frac{U_a}{U_r} \right)^{-n}. \quad (6)$$

This approach has been obtained from [5]. As was already mentioned, based on (6) it is clear, that an  $LT$  estimation model is dependent on electro-thermal processes, which are valid during system operation. It is possible to calculate the lifetime based on (6) from the estimated/ measured values of relevant variables from the system operation. Anyway it is better to think about implementation of the lifetime model into simulation tools and within pre-construction stage to evaluate the expected system behavior. Thus it is possible to significantly optimize the system. This methodology is further described within this paper.

### 3. Life-time estimation model (simulation interface)

During operation of any electronic system, various physical phenomena influence system behavior. Practically it is very difficult to experimentally determine the impact of these physical processes due to the necessity of long-running measurements, or due to the requirements on special measuring equipment (testing chambers etc.).

A possible way to determine how to investigate previously described issues is a multi-level simulation design, where various electrical and non-electrical processes can be considered (Fig. 1 – right).

It is well known that the electrolytic capacitors act as most critical components when we talking about a lifetime. Proper operational conditions (electrical, thermal, etc...) can contribute to extension of these parameters. The proposed system (Fig. 1 – right) enables to investigate/or define proper operational characteristic in order to determine/ or define the expected component lifetime.

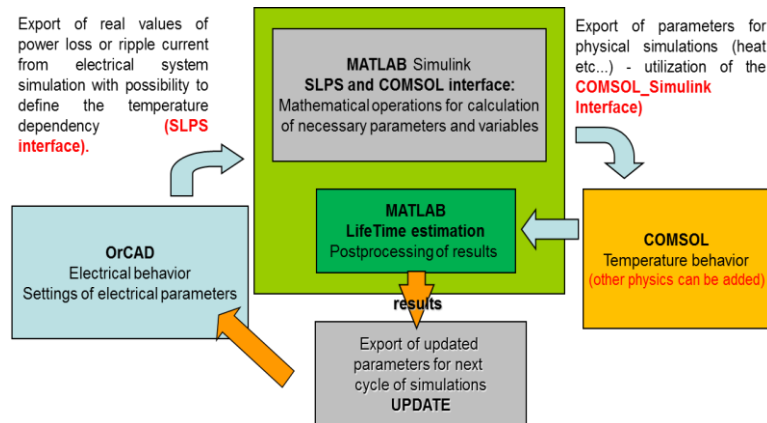

Fig. 1. Proposal for multi-level simulation with consideration of various physical phenomena

For the design of the electrical systems, we decided to use sub-packages from the OrCAD 16.6 software.

Capture/analog or mixed A/D – a schematic editor with a high number of integrated electro physical electrical models:

- Pspice A/D – a simulation substructure of OrCAD that models real electrical behaviour of a circuit. It is possible to simulate the mix of analog and digital devices.

For design of multiphysics models we used COMSOL. The advantages of this software:

- CAD import module for simulation of more complex geometries,
- predefined equations for nonlinear problems (e.g. thermal, magnetic, ambient, mechanical).

For control of co-simulations and for data analysis, we decided to use Matlab:

- m-file – post processing of results, evaluation of convergence, determination of optimal parameter settings.

It is necessary to develop individual models for each simulation module. In the next chapters of this paper, we describe the development process of thermal and electrical modelling of an electrolytic capacitor, including the most necessary dependencies that occur during system operation and are relevant to (6).

#### 4. Capacitor thermal model – model's complexity within internal structure

The internal structure of an electrolytic capacitor consists of several turns of sandwich structure layers with various material properties (Fig. 2). For development of a lifetime estimation model based on multilevel simulation, we decided to investigate a real physical sample of an electrolytic capacitor – Nichicon CE 105EC, series GU (K). The determination of thickness of several layers has been done with the use of a biological light microscope (micrometer

calibration grid) and simultaneously with the use of a dial indicator. Based on the measured values we have deduced the average values of the thicknesses.

For the approximate estimation of the specific values of electrical parameters, i.e. electrical conductivity, we have examined several literary and scientific publications, based on which we were able to estimate conductivity values for electrolyte, that was the main problem in determination of material properties [6].

The layers of the core form a structure that consists of interconnected very thin blocks within the same area, but with different thickness of individual layers. This approach is similar to the one which was done during the PCB thermal modeling of DC-DC converter, during the previous task (Thermal resistances of a block in 3D for “x”, “y”, and “z” were determined by an averaging method).

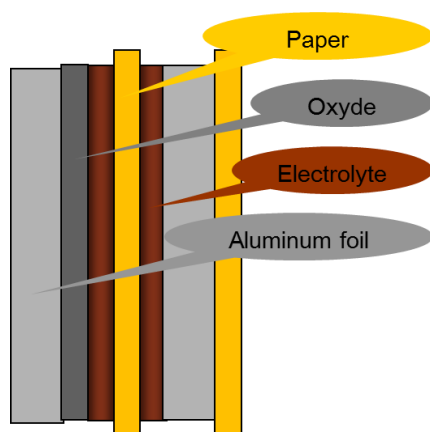

Layer	Material	Width [mm]	Conductivity [S/m]
Anode	Al	0.0001	3.77 e+7
Dielectric	Al <sub>2</sub> O <sub>3</sub>	0.00001	1.00 e-14
Electrolyte	PC	0.00001	1.00 e-10
Isolation	Paper	0.00005	1.00 e-14
Electrolyte	PC	0.00001	1.00 e-10
Cathode	Al	0.0001	3.77 e+7
Isolation	Paper	0.00005	1.00 e-14

Fig. 2. One turn of electrolytic capacitor with material properties of individual layers

There are several possible ways, in which a thermal simulation model can be designed, while complexity and accuracy are main factors that must be considered for a multi-level simulation approach. Modelling of a capacitor core is, therefore, the most important issue. Next, various approaches for capacitor's core thermal modelling will be shown.

#### Structural thermal model

A structured model consists of 90 turns, whereby one turn consists of 7 layers in a sandwich structure in a given order (Fig. 3). This model was done just in 2-D interpretation because of the reduction of computation time during verification processes (3-D interpretation would need a powerful computation machine).

The geometrical model of a structural thermal model consists of meticulously ordered layers of an internal structure of the investigated sample (Fig. 3). The number of turns is equal to 90, cause that the final width of 2D core is equal to 19.5 mm, with a height of 100 mm. This approach is principally very time consuming, but on the other hand, very high accuracy can be achieved due to close proximity to a physical sample.

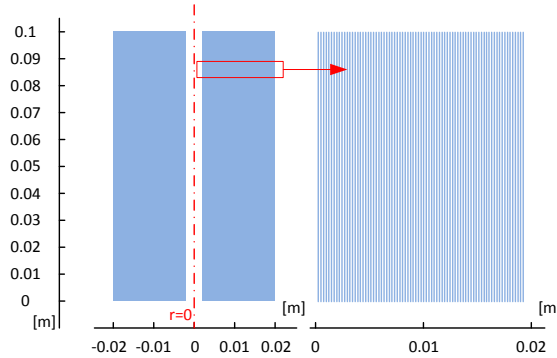

Fig. 3. Structural model of electrolytic capacitor core

### Coil thermal model

A coil model is based on the approximation of thermal resistance in the axial and radial direction of one turn (7 layers), whereby value of thermal conductivity is consequently dependent on the number of turn [7]. The axial element of electrical resistance of individual turns in order  $j \in (1; n)$  is given by (7) and the radial element is defined by (8):

$$R_a(j) = \frac{L}{\sigma_a S(j)}, \quad (7)$$

$$R_r(j) = \frac{1n \frac{r_j}{R_{r-1}}}{2\pi L \sigma_r(j)}, \quad (8)$$

where:  $\sigma_a$ ,  $\sigma_r$  represent the axial and radial electric conductivity of individual layers,  $S(j)$  is the area of the layer,  $r(j)$  is the diameter of the turn in given order,  $L$  is the length of the electrolytic capacitor core (height of capacitor).

Fig. 4 shows dependency of axial and radial element of electric conductivity in dependency on the number of turn of capacitor core, which was derived with the use of (7) and (8) respectively.

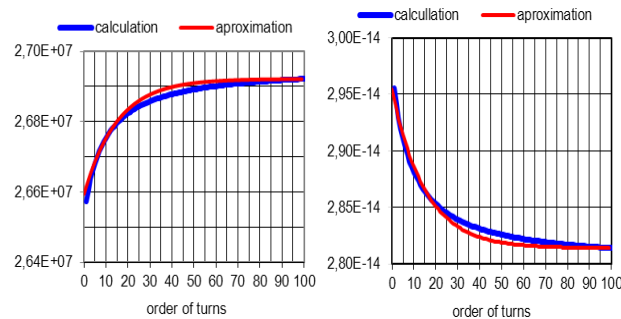

Fig. 4. Dependency of electrical conductivities  $\sigma_a$  and  $\sigma_r$  (S/m) on a number of turns of a capacitor core

At this point, it must be said that for the coil thermal model of a capacitor, the electrical conductivity is introduced as a tensor of 2nd degree. This must be accepted during OrCAD electrical simulations. The core of the electrolytic capacitor is made of anisotropic material which depends on the  $x$ ,  $y$  and  $z$ -axes. The approximated value have been taken from the previous analysis (Fig. 4)

$$\sigma_x = 2.81399 \cdot 10^{-14} + 1.5 \cdot 10^{-15} \cdot e^{\frac{-0.00258 + radius}{0.00195}},$$

$$\sigma_y = 2.81399 \cdot 10^{-14} + 1.5 \cdot 10^{-15} \cdot e^{\frac{-0.00258 + radius}{0.00195}},$$

$$\sigma_z = 2692181 - 349772 \cdot e^{\frac{-0.00258 + radius}{0.00195}},$$

$$radius = \sqrt{x^2 + y^2}.$$

### Sandwich model

As was said, the layers of a capacitor core form a structure which consists of interconnected, very thin blocks within the same area, but with different thickness of individual layers (Fig. 2). This approach is similar to the one where multilayer PCB is considered and modelled for thermal simulations [8]. Thermal resistances of a block in 3D space for „ $x$ “, „ $y$ “, and „ $z$ “, in that case were determined by an averaging method.

For the structure in Fig. 2, it is possible to define average thermal conductivities in a radial and axial direction with the use of (9), (10). A sandwich model contains just one substance with different conductivity in an axial and radial direction.

$$k_r(j) = \frac{\sum_{i=1}^n w_i}{\sum_{i=1}^n \frac{w_i}{k_i}}, \quad (9)$$

$$k_a(j) = \frac{\sum_{i=1}^n w_i \cdot k_i}{\sum_{i=1}^n w_i}, \quad (10)$$

where:  $k_r$  is the averaged thermal conductivity in a radial direction,  $k_a$  is the averaged thermal conductivity in a axial direction,  $w_i$  is the width/thickness of the  $i$ -th layer,  $k_i$  is the thermal conductivity of the  $i$ -th layer.

Within the definition of subdomains, there are two radial parts (in  $x$  and  $y$  direction) and one axial part (in  $z$  direction). This approach is much simpler than precise modeling of a structural model (Fig. 3) and less computation time shall be required. However, the results might be worse compared to structural and coil thermal models.

The aim of development of three different approaches for capacitor's core thermal simulation model was:

- 1) Confirmation of theory that averaged models compared to a structured model are accurately enough for further use.
- 2) Investigation of computation time during 3-D heat transfer simulations with averaged models for *LT* estimation purposes.
- 3) Finding possibilities of reduction of computation time because of use in more complex Life-Time estimation methodology-simulations.

Figs. 5-6 show the simulation results from the investigation of thermal behavior of the capacitor core (we have considered an EPCOS capacitor with the product ID B43511A5158M), when a ripple of the current, flowing through the core is being changed. The simulation was done for different values of the ripple, while two approaches of the simulation model were compared – an averaged non-structural model (Fig. 2) and a structural model (Fig. 3). Zero on the *x*-axis is representing the middle point of the capacitor, and the maximum on the right side of *x*-axis represents the side of the capacitor.

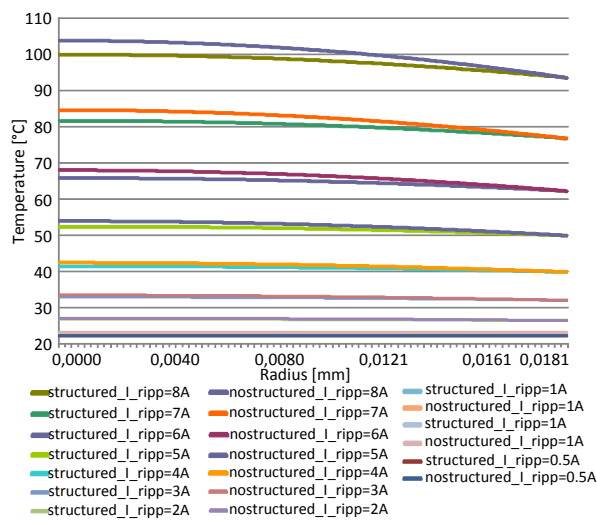

Fig. 5. Summary from simulation comparison between structural and averaged model for various value of ripple current

It can be seen, that the temperature difference between the structural and averaged model (sandwich model) becomes higher with the increase of the value of the current ripple. The highest error is observed in the proximity of the core. Even for higher values of the ripple current, the relative error is below 5%, which is a target of most of precise simulation models, when comparing to experimental measurements [9].

The target of this point was the confirmation of physical abilities of averaged nonstructural models, because these models are simpler and require much less computation power and computation time for heat transfer simulations. The main point for this evaluation was heat distribution in the core of the capacitor, which has a layered structure. From the previous results it can be seen, that physical interpretation of a nonstructural model shows good accordance with the value of *I* ripple = 8 A, at which a relative error is 4% (this result is valid for the



centre of the core). We decided to provide this experiment in order to facilitate the acceptance of the results, which will be obtained during a lifetime estimation process with nonstructural models of capacitors.

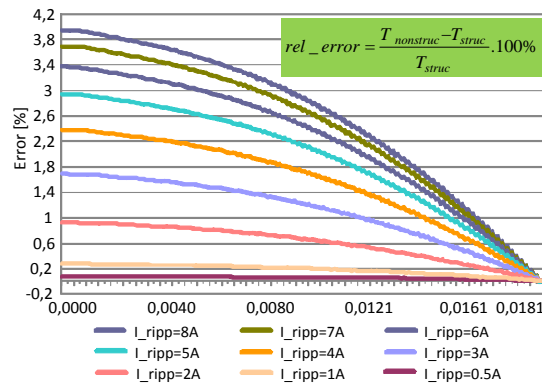

Fig. 6. Relative error from simulation experiments of heat distribution for various current ripple

### 5. Capacitor electrical model – ESR nonlinearity

It is well known that temperature dependency of ESR influences the lifetime of capacitors. The main problem during initial circuit modelling was the development of an electrical model of the investigated capacitor’s ESR that will be temperature dependent. Standard libraries in OrCAD do not have such a model, therefore it was necessary to develop a personal model. For this purpose, and after many attempts the optimal way, how to design the electrical model of ESR with temperature dependency was found out – the use of ABM (Analog Behavioral model) modeling.

The main advantage of the proposed approach is that it is possible to calculate the values of temperatures almost during the computational process of system level simulation (the temperature of ESR is defined as the temperature of the core of the investigated capacitor sample), whereby the capacitor heat transfer behavior is computed – simulated in COMSOL and consequently actual values are exported into OrCAD Capture. A temperature-dependent resistor (or thermistor) can be modeled with help of a look-up table, or an expression can be used to describe how the resistance varies with temperature. The denominator in the expression in Fig. 7 is used to describe common thermistors. The  $T_{val}$  variable in the expression is the simulation temperature, in Celsius. This is then converted to Kelvin by adding 273.15. This step is necessary to avoid a divide by zero problem in the denominator, when  $T = 0EC$  [10, 11].

With the use of ABM modelling it is possible to design various electrical devices (inductors, LEDs, diodes...), together with possibility of entering the values during computational/simulation process.

The temperature dependency of transistors is already included in factory models of OrCAD Capture, whereby their interface for the external definition of actual values is already done, so this simplifies future tasks.

The main electrical parameters of a power test circuit are:  
 Input voltage = 240 Vdc, output voltage = 400 Vdc, output power = 1 kW, switching frequency = 100 kHz.

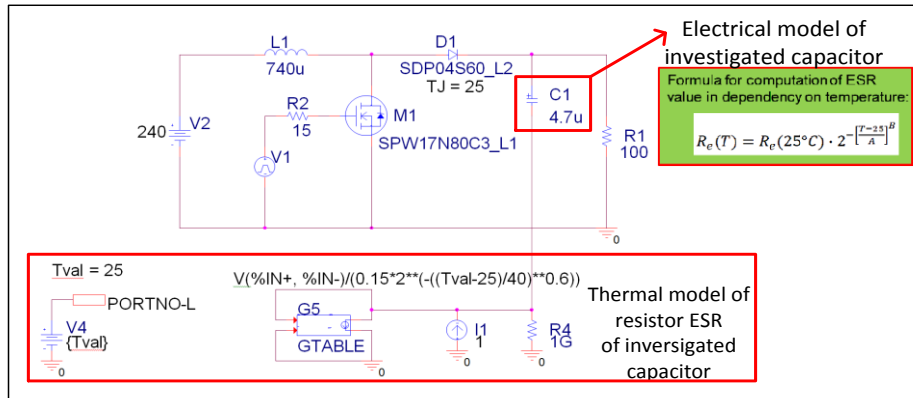

Fig. 7. Implementation of capacitor's ESR temperature nonlinearity into electrical model of capacitor

## 6. Implementation and results

We have designed multi-level simulation for the determination of a lifetime of an electrolytic capacitor in a DC-DC converter (Fig. 8). The simulation model considers these physical phenomena relevant for lifetime estimation:

- Electrical – with given parameters of voltage stress, current ripple stress and with the possibility of define nonlinear component behavior (e.g. temperature dependence of capacitor's ESR).
- Thermal – with given parameters like ambient temperature, air velocity and with a variable parameter like component temperature (electrical dependence).

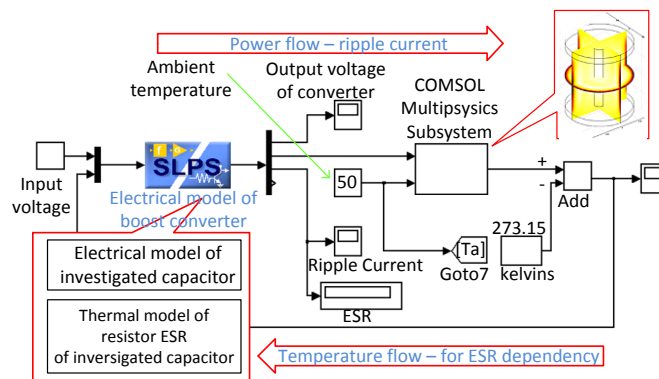

Fig. 8. Proposed multi-level simulation model for lifetime estimation with consideration of various physical phenomena

In order to provide precise multi-level simulation, it is required to design precise simulation models for selected modules. Therefore a very accurate thermal simulation model was developed in COMSOL, and consequently implemented into the circuit simulator of SLPS interface (Matlab – OrCAD).

The simulation results from Fig. 8 are shown in Fig. 9. After several runs of simulations, during which critical operational parameters vary, the lifetime dependence on given parameters can be plotted. It must be mentioned here, that this dependency considers other sub-dependencies, like nonlinearity of an ESR capacitor, temperature dependency of the capacitor core, current ripple dependency etc. Estimation of  $LT$  was done considering Eq. (6).

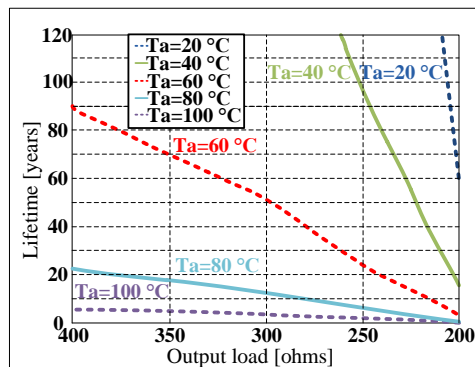

Fig. 9. Estimated lifetime for investigated capacitor in dependency on ambient temperature and output load of converter

The proposed algorithm is also able to determine operating conditions, within which the chosen lifetime of components shall be fulfilled. For example, if we want to have  $LT$  operating from 15 to 25 years, then the operation of the capacitor must be relevant to operation a conditions, which are defined in Fig. 10.

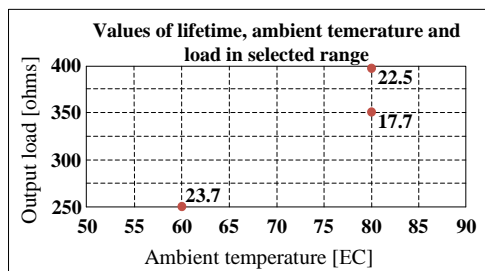

Fig. 10. The estimated lifetime of the investigated capacitor depending on ambient temperature and output load of a converter

## 7. Conclusion

At this point we would like to conclude, that design of multi-level simulation can be helpful in the case of complex and expensive electrical systems investigation, where experimental

testing of various physical phenomena is very time-consuming, or costly. The chosen methodology considers the precise and accurate simulation sub-models of the selected component – an electrolytic capacitor. Complexity of such sub-models cannot be high due to acceptable requirements on computational time. Therefore more variations of a thermal model were designed in order to investigate the relative error of simplified models. Temperature is the most critical parameter which is influencing a lifetime and operation of capacitors. It is necessary to consider nonlinear thermal dependency of parasitic elements during the simulations. We found a possible solution in the way of utilization of analog behavioral modelling. Also other variables must be considered, e.g. humidity, mechanical stress, etc. This will be implemented within the proposed methodology and will be a future task of this work.

### Acknowledgements

The authors wish to thank VEGA, the Slovak Grant Agency, for project no. 1/0558/14 – “Research of methodology for optimization of lifetime of critical components in perspective electronic appliances through the use of system level simulation”.

### References

- [1] Varde P.V., *Physics-of-Failure Based Approach for Predicting Life and Reliability of Electronics Components*, Barc Newsletter, vol. 313 (2010).
- [2] Gasperi M.L., *A Method for Predicting the Expected Life of Bus Capacitors*, IEEE Industry Application Society, Annual Meeting, Louisiana, New Orleans, USA (1997).
- [3] Băzu M., Gălăteanu L., Ilian V.E., Vârșescu D., *Lifetime prediction for components with scarce data: The “worst case” approach*, IEEE 17th International Symposium for Design and Technology in Electronic Packaging (SIITME), Timisoara, Romania, pp. 309-312 (2011).
- [4] Nicolics J., Mundlein M., Hanreich G., Zluc A., Stahr A., Franz M., *Thermal Analysis of Multilayer Printed Circuit Boards with Embedded Carbon Black-Polymer Resistors*, 30th International Spring Seminar on Electronics Technology (ISSE), Cluj-Napoca, Romania, pp. 46-52 (2007).
- [5] Albertsen A., *Electrolytic capacitor lifetime estimation*, Jianghai Europe GmbH (2010).
- [6] Mirsky G., *Determining end of life, ESR, and lifetime calculations for electrolytic capacitors at higher temperatures*, EDN (2008).
- [7] Frivaldsky M., Cuntala J., Spanik P., *Simple and accurate thermal simulation model of super-capacitor suitable for development of module solutions*, International journal of thermal sciences, vol. 84, pp. 34-47 (2014).
- [8] Pspice SLPS Interface Users Guide Ver. 2.5, Cybernet Systems CO., LTD (2004).
- [9] Hruska K., Kindl V., Pechanek R., *Design and FEM analyses of an electrically excited automotive synchronous motor*, Proceedings of Power Electronics and Motion Control Conference (EPE/PEMC), Novi Sad, Serbia, pp. LS2e.2-1 - LS2e.2-7 (2012).
- [10] Grman L., Hrasko M., Kuchta J., *Single phase PWM rectifier in traction application*, Journal of Electrical Engineering, vol. 62, pp. 206-212 (2011).
- [11] Park K.H., Yi K.H., *Cost-effective power system with an electronic double layer capacitor for reducing the standby power consumption of consumer electronic devices*, Journal of power Electronics, vol. 13, pp. 329-338 (2013).